

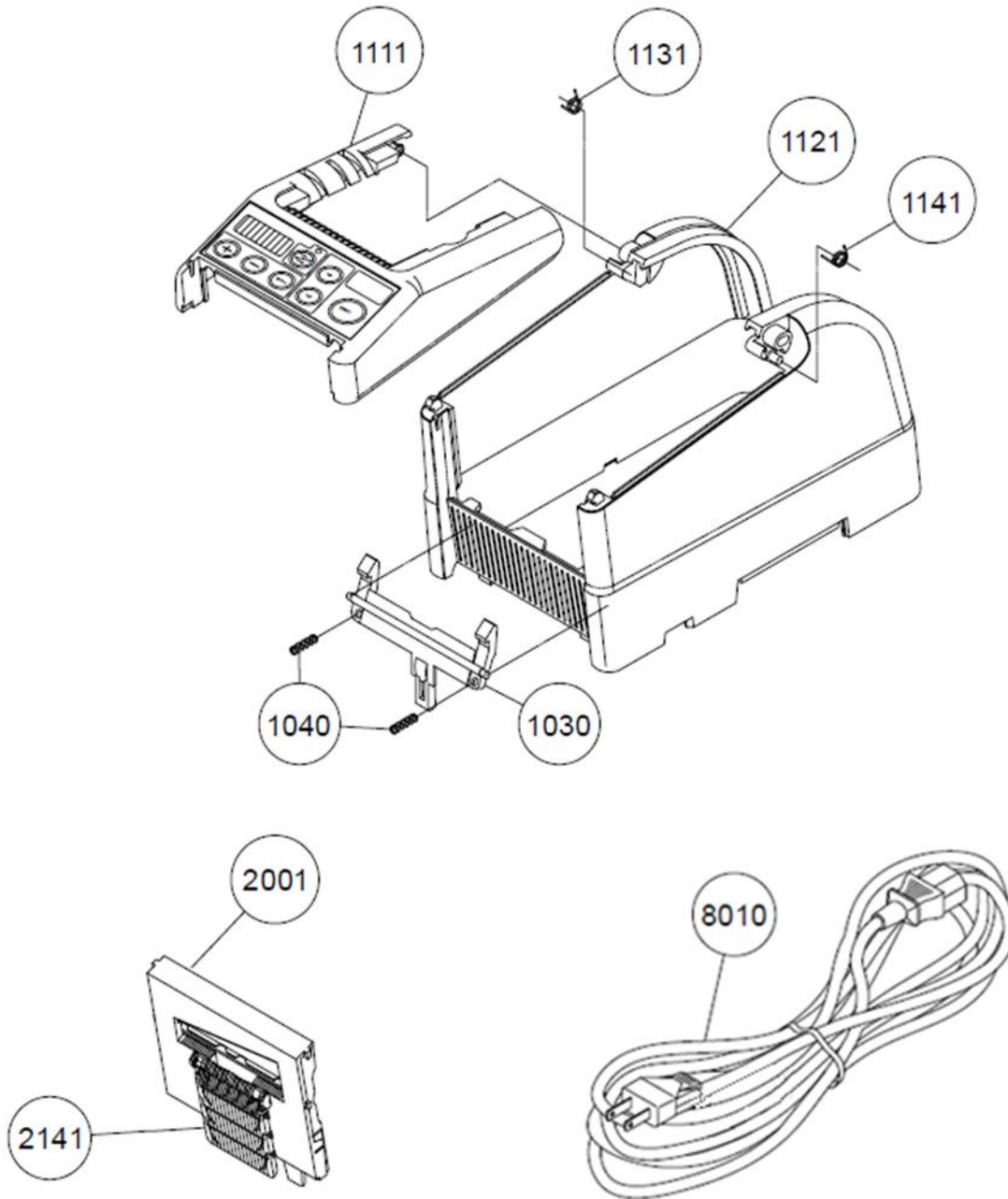

EZ-9000GR Tape Dispenser
Part Number 66136
May 26, 2017



ASG, Division of Jergens, Inc.

15700 S. Waterloo Road | Cleveland, OH 44110-3898
Phone: (888) 486-6163 | Fax: (216) 481-4519
Email: asginfo@asg-jergens.com | Web: www.asg-jergens.com



EZ-9000GR Tape Dispenser
Part Number 66136
May 26, 2017



Change Note Feb. 2016

#6211 is not available as a separate part. It is supplied as part of #6110

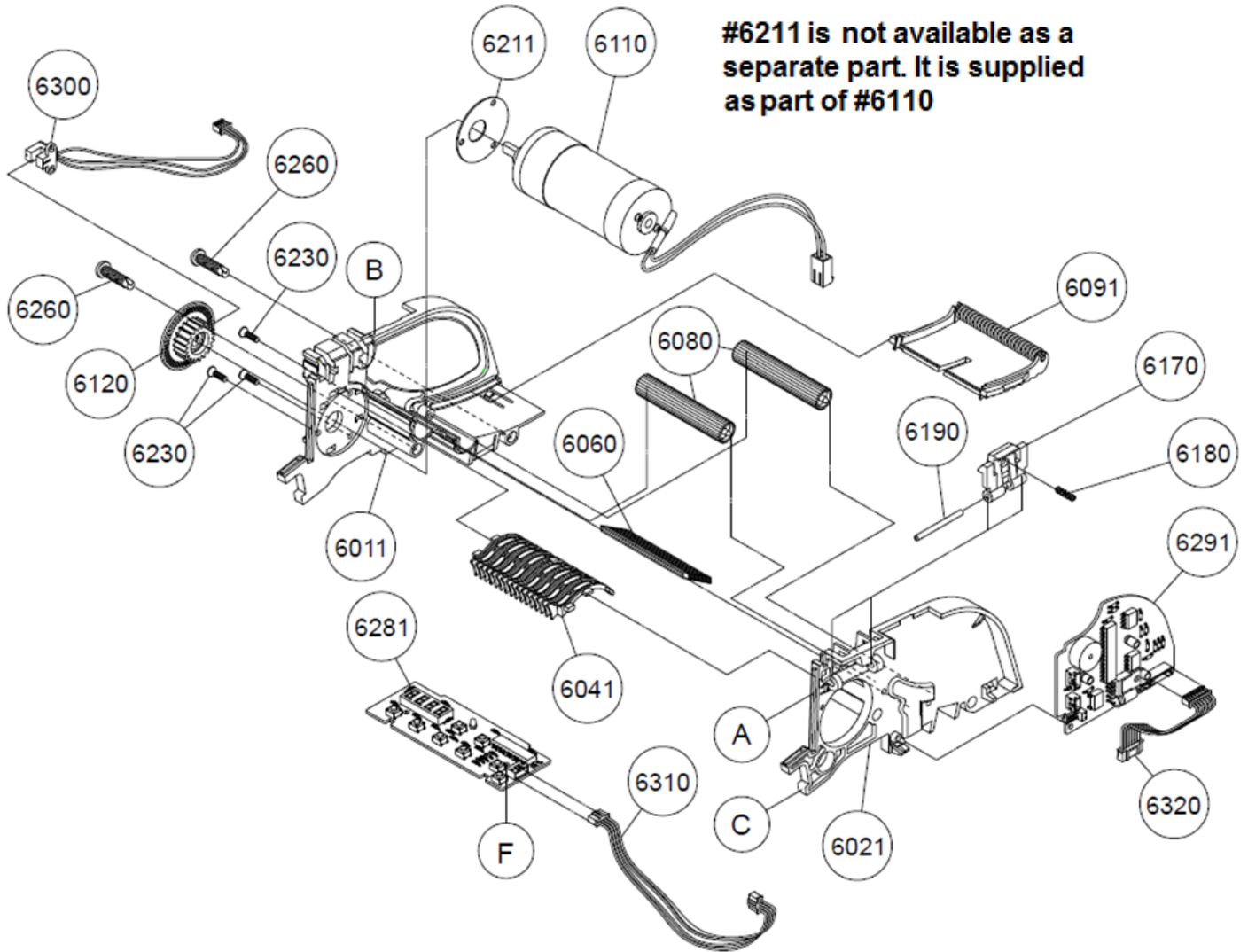

ASG, Division of Jergens, Inc.

15700 S. Waterloo Road | Cleveland, OH 44110-3898
Phone: (888) 486-6163 | Fax: (216) 481-4519
Email: asginfo@asg-jergens.com | Web: www.asg-jergens.com



EZ-9000GR Tape Dispenser
Part Number 66136
May 26, 2017

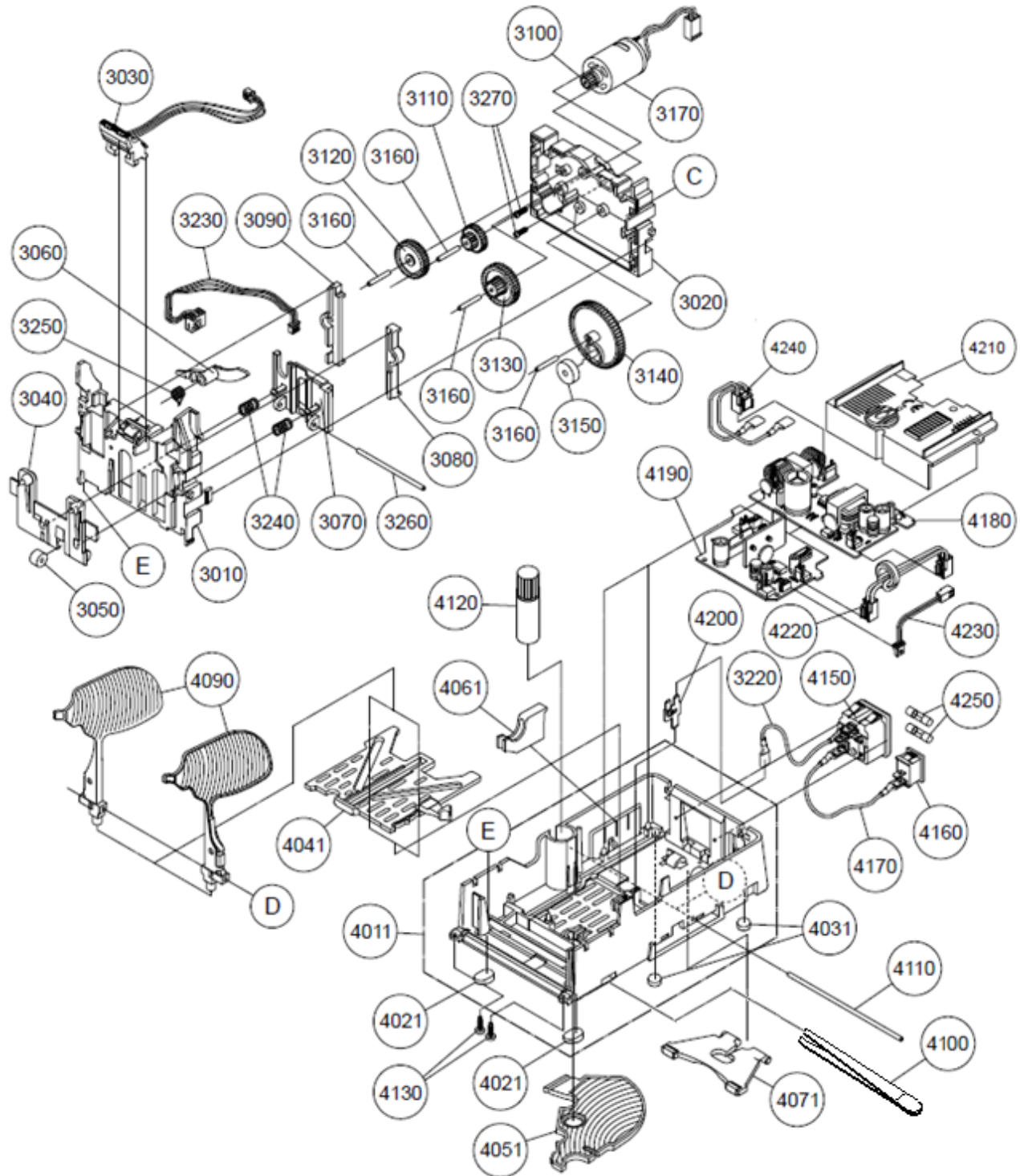









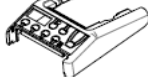

ASG, Division of Jergens, Inc.

15700 S. Waterloo Road | Cleveland, OH 44110-3898
Phone: (888) 486-6163 | Fax: (216) 481-4519
Email: asginfo@asg-jergens.com | Web: www.asg-jergens.com

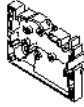

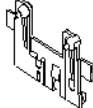
EZ-9000GR Tape Dispenser
Part Number 66136
May 26, 2017



Ref.	Part #	Part Name	Figure	Notes
1001	750349	BODY SET		INCLUDES DRAWING ITEMS 1030, 1040, 1111 1121, 1131, 1141
1111	750350	UPPER BODY		
	N/A	CONTROL PANEL		PART OF 1111
2001	750351	BLADE UNIT		
2141	750352	FLEXIBLE TAPE SUPPORT		INCLUDED WITH 2001
3010	750003	GEAR BOX FRONT		
3020	750004	GEAR BOX REAR		
3030	750005	TAPE SENSOR		
3040	750006	SLIDE PLATE		
3050	750007	PLATE ROLLER		
3060	750008	SENSOR LEVER		
3070	750009	BLADE PLATE		













ASG, Division of Jergens, Inc.

15700 S. Waterloo Road | Cleveland, OH 44110-3898
 Phone: (888) 486-6163 | Fax: (216) 481-4519
 Email: asginfo@asg-jergens.com | Web: www.asg-jergens.com



EZ-9000GR Tape Dispenser
Part Number 66136
May 26, 2017



Ref.	Part #	Part Name	Figure	Notes
3080	750010	CAM FIX BAR (LEFT)		
3090	750011	CAM FIX BAR (RIGHT)		
3100	N/A	BLADE MOTOR GEAR		PART OF 3170
3110	750012	BLADE GEAR #1		
3120	750013	BLADE GEAR #2		
3130	750014	BLADE GEAR #3		
3140	750015	BLADE MAIN GEAR		
3150	750016	BLADE GEAR BEARING		
3160	750017	BLADE GEAR SHAFT		SET OF 4 PCS.
3170	750018	BLADE MOTOR		INCLUDES 3100
3220	750022	INLET CABLE		
3230	750023	BLADE SENSOR		











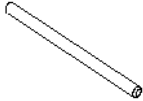

ASG, Division of Jergens, Inc.

15700 S. Waterloo Road | Cleveland, OH 44110-3898
 Phone: (888) 486-6163 | Fax: (216) 481-4519
 Email: asginfo@asg-jergens.com | Web: www.asg-jergens.com



EZ-9000GR Tape Dispenser
Part Number 66136
May 26, 2017



Ref.	Part #	Part Name	Figure	Notes
3240	750024	COIL SPRING		SET OF 2 PCS.
3250	750025	SPRING		
3260	750026	PLATE SHAFT		
3270	750027	SCREW M2.6 x 6L		SET OF 2 PCS.
4011	750353	BASE SET		INCLUDES DRAWING ITEMS 4011, 4021, 4031, 4041
4051	750354	SEPARATOR		
4061	750355	GUIDE PLATE		
4071	750356	SUPPORT STAND		
4090	750033	TAPE HOLDER SET		SET ONLY, INCLUDES DRAWING ITEM 4110
4100	750034	TWEEZERS		
4120	750035	SILICON OIL		
4130	750036	SCREW M3 x 6L		











ASG, Division of Jergens, Inc.

15700 S. Waterloo Road | Cleveland, OH 44110-3898
 Phone: (888) 486-6163 | Fax: (216) 481-4519
 Email: asginfo@asg-jergens.com | Web: www.asg-jergens.com



EZ-9000GR Tape Dispenser
Part Number 66136
May 26, 2017

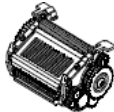

Ref.	Part #	Part Name	Figure	Notes
4150	750038	INLET		
4160	750039	POWER SWITCH		
4170	750040	INLET CABLE		
4180	750201	P.C.B. (D)		
4190	750093	P.C.B. (E)		
4200	750202	EARTH TERMINAL		
4210	750203	P.C.B. COVER		
4220	750204	JOINT CABLE 24V		
4230	750205	JOINT CABLE 9V		
4240	750206	INLET CABLE		
4250	750368	FUSE (2A) EA.		
5001	750357	REMOVEABLE ROLLER SET		INCLUDES 5011 ~ 5320







ASG, Division of Jergens, Inc.

15700 S. Waterloo Road | Cleveland, OH 44110-3898
 Phone: (888) 486-6163 | Fax: (216) 481-4519
 Email: asginfo@asg-jergens.com | Web: www.asg-jergens.com

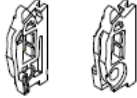
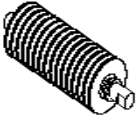
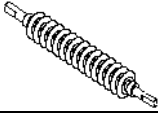
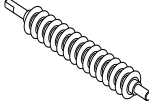

EZ-9000GR Tape Dispenser
Part Number 66136
May 26, 2017

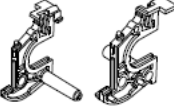

Ref.	Part #	Part Name	Figure	Notes
5011	750358	FRONT FRAME SET INCL 5021		
5021	N/A			PART OF 5011
5030	750044	ROLLER #3		
5040	750045	ROLLER #5		
5050	750059	ROLLER #4		
5061	750361	TAPE GUIDE		
5071	750362	ROLLER BUSHING		SET OF 2 PCS.
5080	750049	ROLLER SPRING		SET OF 2 PCS.
5110	750097	M.R GEAR		
5111	750359	ROLLER FRAME SET INCL 5121		
5120	750633	I. GEAR		
5121	N/A			PART OF 5111









ASG, Division of Jergens, Inc.

15700 S. Waterloo Road | Cleveland, OH 44110-3898
 Phone: (888) 486-6163 | Fax: (216) 481-4519
 Email: asginfo@asg-jergens.com | Web: www.asg-jergens.com

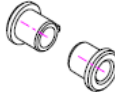

EZ-9000GR Tape Dispenser
Part Number 66136
May 26, 2017

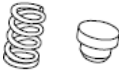

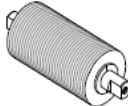
Ref.	Part #	Part Name	Figure	Notes
5130	750054	R.D. GEAR		
5140	750055	L.R. GEAR		
5191	750363	BUSHING		
5201	750364	CHECK PLATE		
5210	750066	ROLLER #1		
5220	750073	P.R. GEAR		
5231	750365	LARGE ROLLER BUSHING		
5241	750366	COIL SPRING SET		INCLUDES 5251
5251	N/A			PART OF 5241
5260	750053	I. GEAR		
5271	750369	SCREW M3 X 8L		
5281	750367 750064	ROLLER #2		750367 SILICONE 750064 PLASTIC









ASG, Division of Jergens, Inc.

15700 S. Waterloo Road | Cleveland, OH 44110-3898
 Phone: (888) 486-6163 | Fax: (216) 481-4519
 Email: asginfo@asg-jergens.com | Web: www.asg-jergens.com

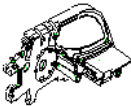
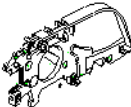
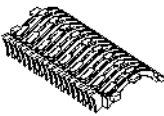

EZ-9000GR Tape Dispenser
Part Number 66136
May 26, 2017

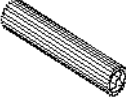
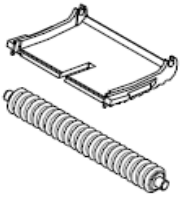

Ref.	Part #	Part Name	Figure	Notes
5291	750513	ROLLER SHAFT BRACKET		
5300	750071	R. GEAR		
5310	750072	D. GEAR		
5320	750082	SCREW M4 X 8L		
6011	750514	MAIN FRAME LEFT		
6021	750515	MAIN FRAME RIGHT		
6041	750516	TAPE REGULATING PLATE		
6060	750065	BRUSH		
6080	750067	TAPE SUPPORT ROLLER		SET OF 2 PCS.
6091	750519	LOWER TAPE HOLDER		
6110	750069	MOTOR		INCLUDES 6211







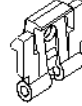

ASG, Division of Jergens, Inc.

15700 S. Waterloo Road | Cleveland, OH 44110-3898
 Phone: (888) 486-6163 | Fax: (216) 481-4519
 Email: asginfo@asg-jergens.com | Web: www.asg-jergens.com

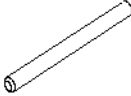

EZ-9000GR Tape Dispenser
Part Number 66136
May 26, 2017

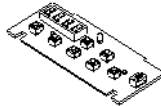
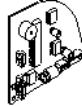

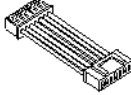
Ref.	Part #	Part Name	Figure	Notes
6120	750070	ENCODER		
6170	750075	PLATE HANGER		
6180	750076	HANGER SPRING		
6190	N/A	TAPE GUIDE SET PIN		PART OF 7000
6230	750081	SCREW M3 x 6L		SET OF 3 PCS.
6260	750084	SCREW 4 x 12L		SET OF 2 PCS.
6270	N/A	HOLD DOWN ROLLER SPRING		PART OF 7000
6281	750517	P.C.B. (A)		
6291	750518	P.C.B. (B)		
6300	750087	LENGTH SENSOR		
6310	750088	P.C.B. (A) CABLE		
6320	750207	P.C.B. (B) CABLE		



ASG, Division of Jergens, Inc.

15700 S. Waterloo Road | Cleveland, OH 44110-3898
 Phone: (888) 486-6163 | Fax: (216) 481-4519
 Email: asginfo@asg-jergens.com | Web: www.asg-jergens.com



EZ-9000GR Tape Dispenser
Part Number 66136
May 26, 2017

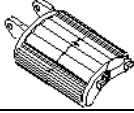

Ref.	Part #	Part Name	Figure	Notes
7000	750090	HOLD DOWN ROLLER UNIT		INCLUDES 6190, 6270
	721997	POWER CORD		UL(120V)

The "RP" model consists of a normal EZ-9000GR attached to a base which holds the "RP" assembly.

The following are the only parts available for the "RP assembly

#915850 RP Kit, Includes;

#725123 Bracket RP Stand, attaches bobbins to the base.

#725125 Base RP Stand, attaches the bracket to the dispenser.

#725127 Bobbin Assembly, includes all plastic parts and hardware to mount the plastic parts to the bracket. These parts will come attached to a red metal bracket that will be discarded.

NOTE Individual plastic parts or hardware not available separately.

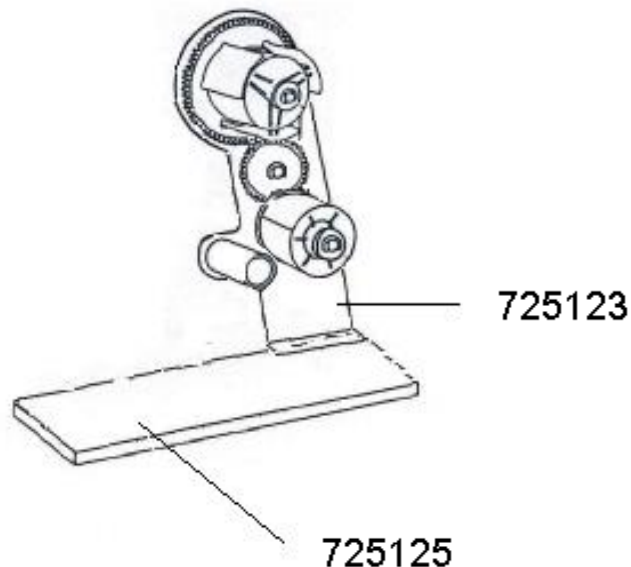

ASG, Division of Jergens, Inc.

15700 S. Waterloo Road | Cleveland, OH 44110-3898

Phone: (888) 486-6163 | Fax: (216) 481-4519

Email: asginfo@asg-jergens.com | Web: www.asg-jergens.com